

MATLAB EXPO

Pragmatic Digital Transformation Through the Systematic Use of Data and Models

Jim Tung
MathWorks Fellow



Consider the doorbell



Access to the cloud

Add a camera



Add a motion sensor



Is this still a doorbell?

Digital transformation has changed the doorbell

Digital technology

- HD video
- Motion detection
- Smartphone interface
- AWS Cloud



Digital transformation has changed the doorbell

Digital technology

- HD video
- Motion detection
- Smartphone interface
- AWS Cloud

Business value

- Amazon buys Ring for \$1.2 billion+ in 2018

Amazon Acquires Ring, Maker of Video Doorbells

Front-door monitoring device plays to buyer's ambitions in home-security business

Digital transformation has changed the doorbell

Digital technology

- HD video
- Motion detection
- Smartphone interface
- AWS Cloud

Business value

- Amazon buys Ring for \$1.2 billion+ in 2018

New revenue opportunities

- “Ring Protect” subscription plans (\$99-\$499)
- Additional security with Ring Alarm kit
- More secure delivery through Amazon Key

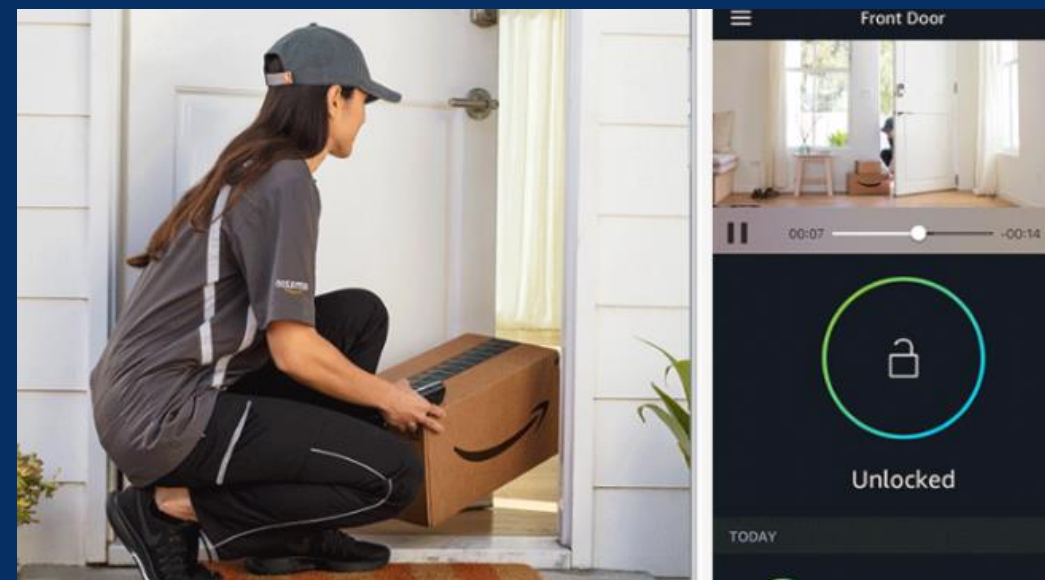

Who and what were required to undergo this transformation?

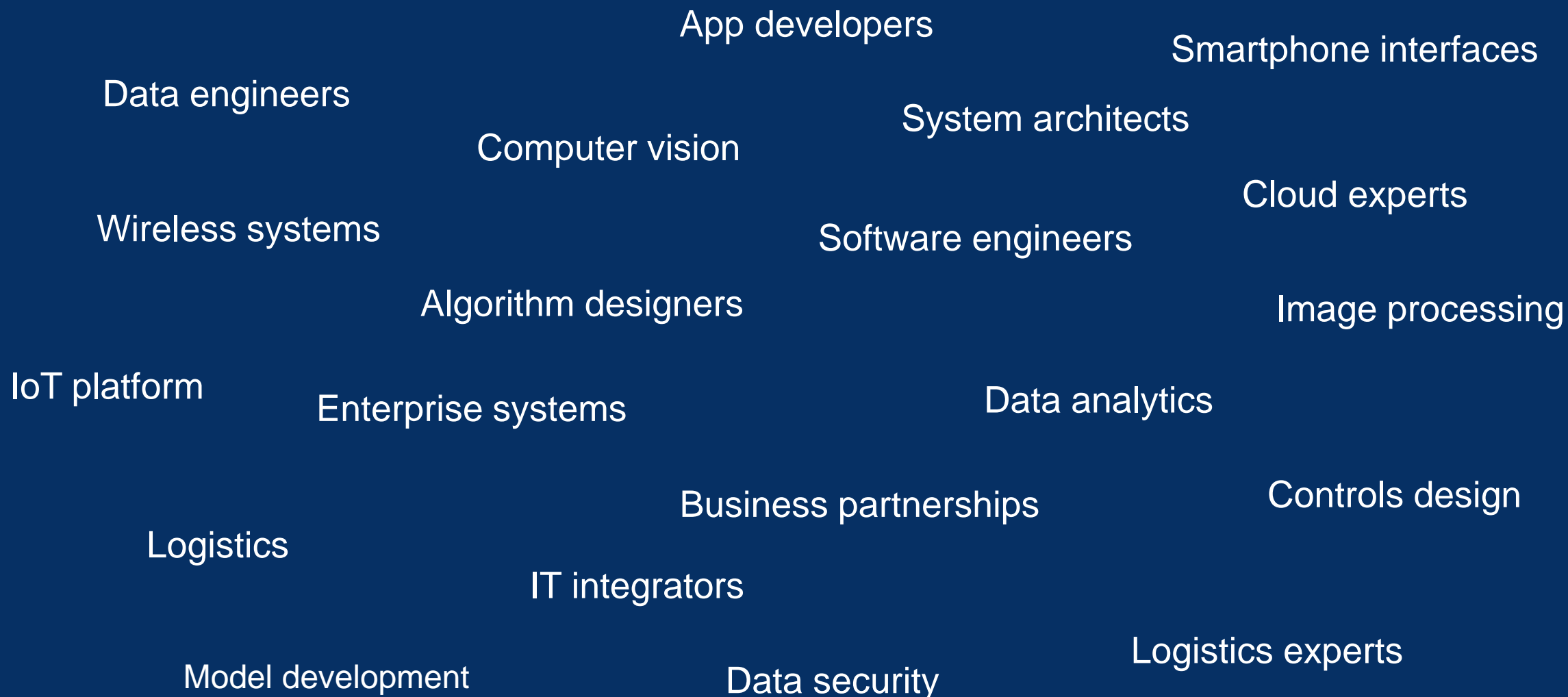

People

Data engineers
 Algorithm designers
 App developers
 IT integrators
 Cloud experts
 Software engineers
 System architects
 Logistics experts

Processes

Logistics
 Business partnerships
 Data security
 Enterprise systems
 Model development
 Data analytics

Technologies

Controls design
 Smartphone interfaces
 Wireless systems
 Image processing
 Computer vision
 IoT platform

More than just doorbells ...

Industrial Automation



Individually customized
manufactured units

Automotive



Fully autonomous
driving capabilities

Utilities & Energy



Increased energy efficiency
with predictive maintenance

Medical



Wearable devices to
monitor mental health

Aerospace



Global management
of aircraft fleet

Finance



Real-time data analytics
for predictive insights

Why Digital Transformation?

Do things better Optimization

- Optimize design performance in-operation
- Predict when system needs maintenance
- Manage a fleet of connected systems

Do new things Transformation

Why Digital Transformation?

Do things better Optimization

- Optimize design performance in-operation
- Predict when system needs maintenance
- Manage a fleet of connected systems

Do new things Transformation

- Go into new industries and markets
- Expand into an entire platform service
- Provide unique value to your customer

The doorbell illustrates both types

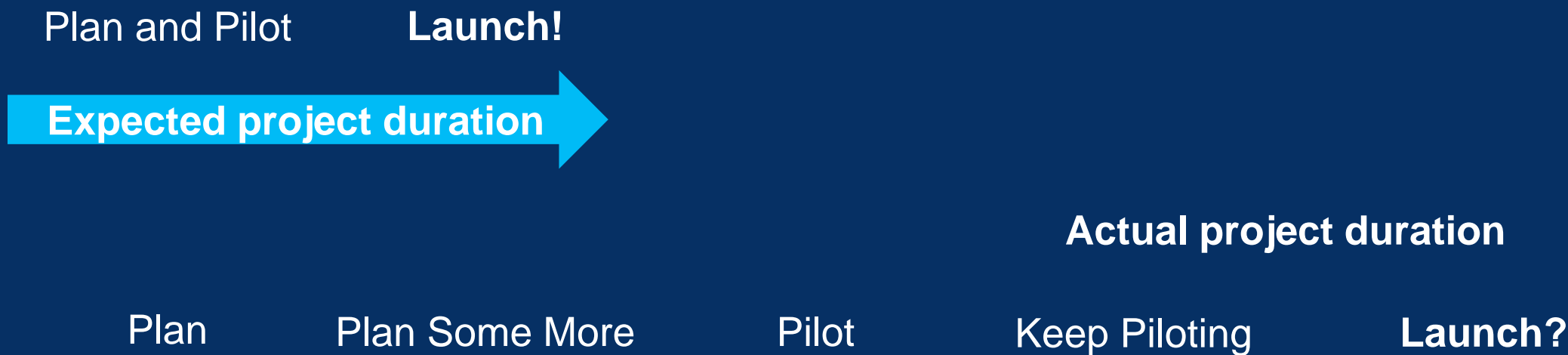

**< 20% of organizations are on target
with their digital transformation objectives**

Source: McKinsey, *Can IT Rise to the Digital Challenge?*, October 2018.

Why is it hard?

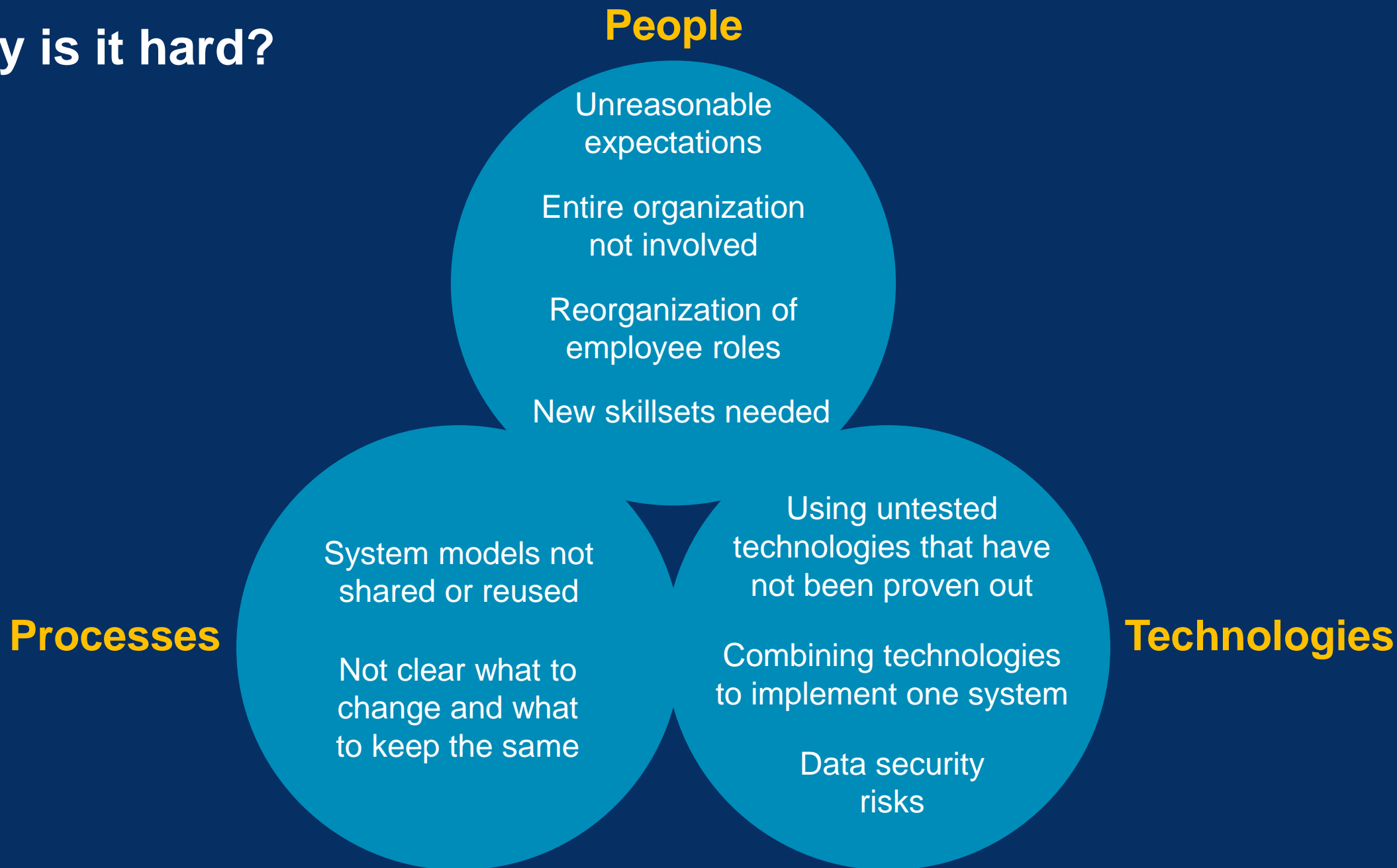

What approaches have people tried?



Big Bang Approach

Build complete infrastructure first
Value not delivered to customer

Risky

Pragmatic Approach

Build on models you already have
Extend beyond siloed use of data

Unleash untapped value



Siloed Approach

Each group works in own silo
Stuck in business model

Obsolete

Pragmatic Digital Transformation

Systematic use of data and models
to **create** and **deliver** superior value to customers
throughout the entire lifecycle

Systematic Use of Data

Data centralization has made engineering even more difficult

Field data



System data



User data



Environment data



Data diversity complexity

- Engineering, Scientific, and Field
- Business & transactional
- Noisy, Outliers, Missing data
- Time series synchronizing

Modern data management multiplies complexity

- Proliferation of data systems
- More siloes
- Cloud, on-premise, hybrid
- Big Data

Big Data



CLUDERA

Cloud Platforms



Example: GSK Consumer Healthcare

Using big batch process data to make better products



£1 billion brand

~8% growth

Close to capacity at all 20+ factories



“Trying to squeeze every last drop of efficiency ...

Last thing we want to do is build another toothpaste factory”

Dr. Bob Sochon

Challenge #1: Big data lives in many siloes

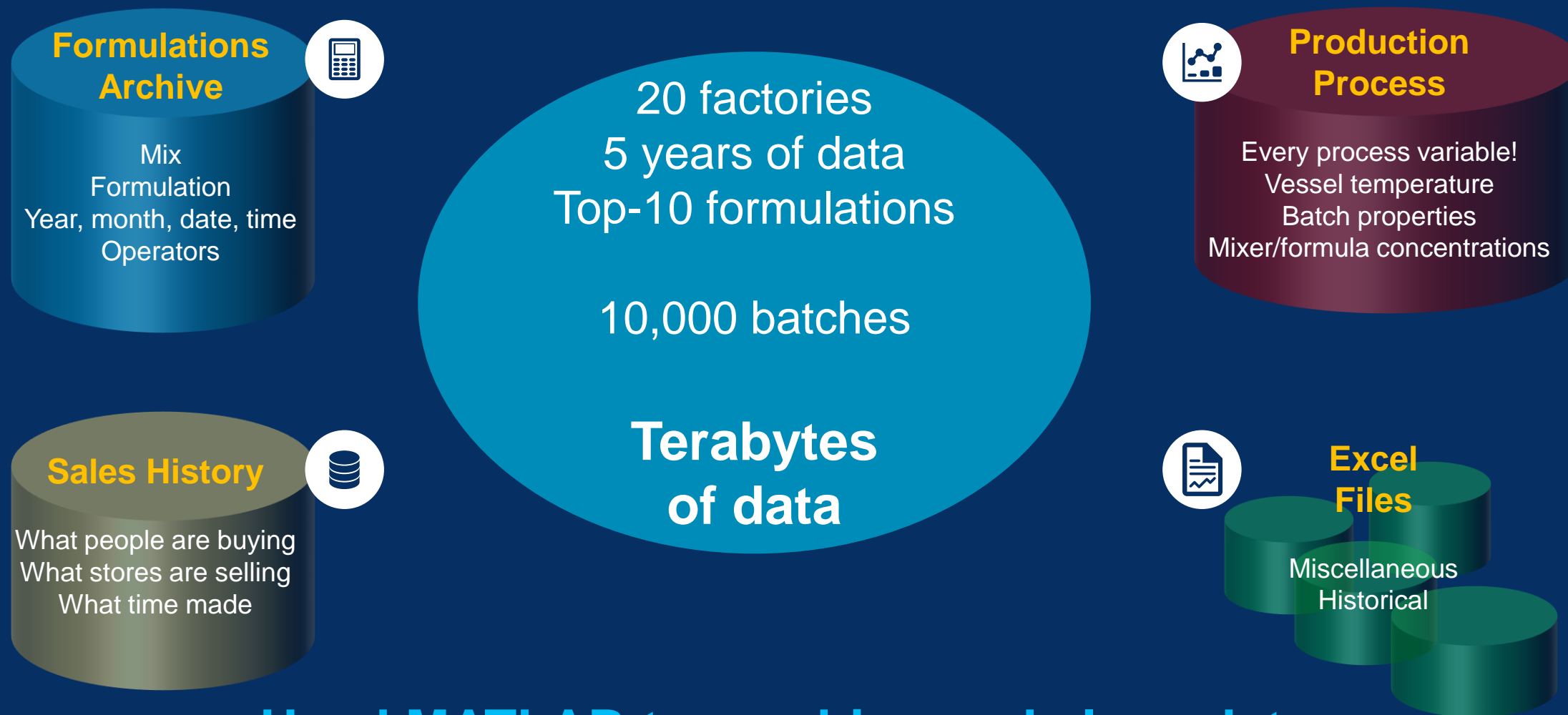

Used MATLAB to combine and clean data

Challenge #2: Need systematic pre-processing



Production
Process

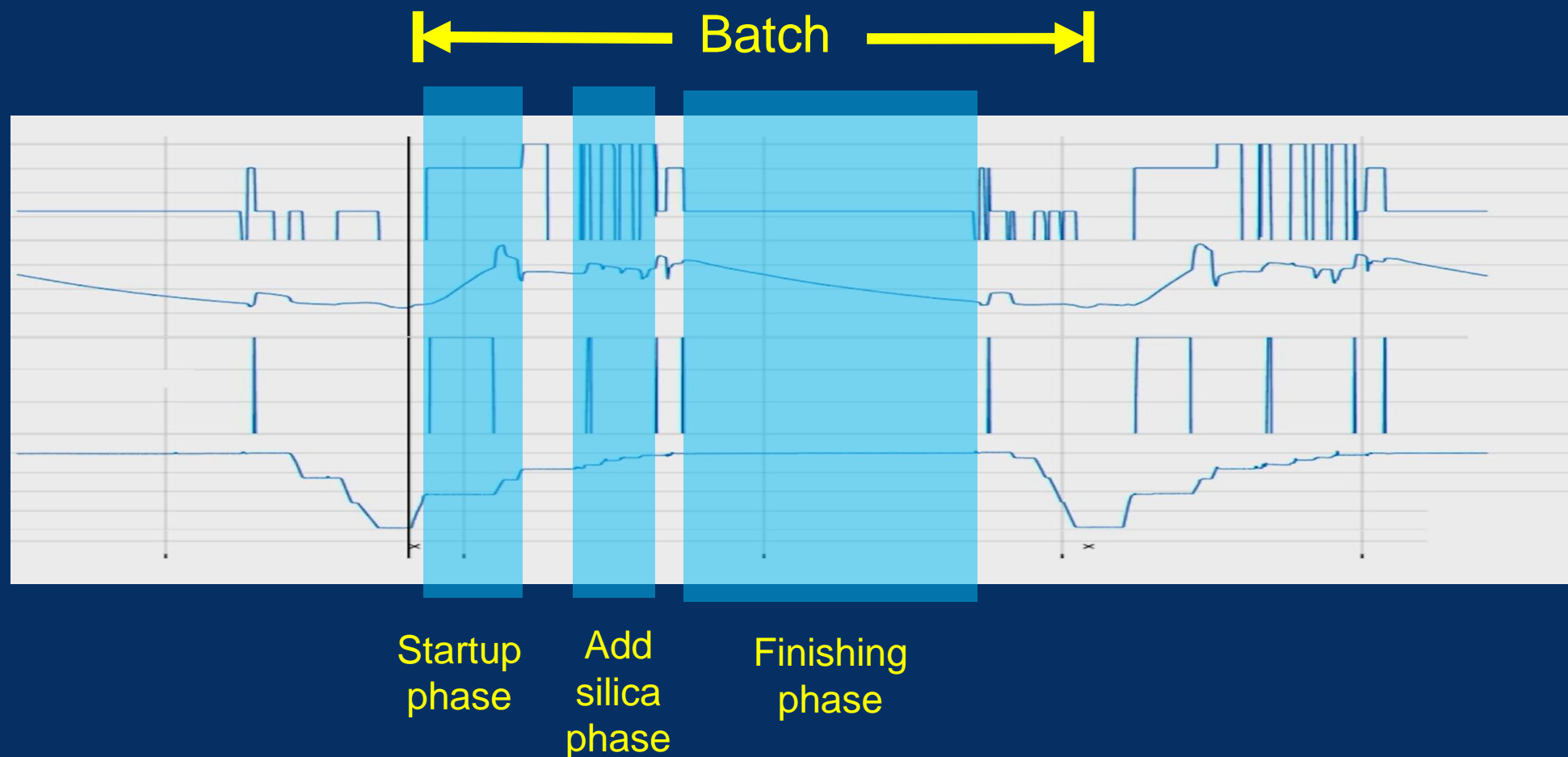

Used MATLAB to sort and tag data by phase

Challenge #3: Need systematic views of data

Formulations
Archive



Sales History



Production
Process



Excel
files



The screenshot shows a software interface with the following sections:

- Data Folders:**
 - IP21 Data: IP21Data
 - Operator Data: OperatorData
 - LIMS Data: LIMSData
 - Phase Definitions: PhaseDefinitions
 - Output Folder: Archives
- Mixer/Formula Combination:**

Formula	Mixer Number
U3004	Mixer 1
U3008	Mixer 3
U3440	Mixer 4
U3442	Mixer 5
U3444	
U3530	
U3531	
U3532	
- Data Analysis - Preprocessing:**
 - Run Stages:**
 - Segment Batches
 - Refresh data archive
 - Segment Phases
 - Add LIMS data
 - Refresh LIMS archive
 - Analyse
 - Refresh Statistics
 - Properties:**
 - No. Batches: Inf
 - Skip Batches: 0
 - Phase Cutoff: Inf
 - Verbosity: 2
 - Batch Segmentation:**
 - Stage: Premix, Mix
 - Start/End: Start, End
 - Seg Var: G2_Weight
 - Cut Direction: Increasing
 - Cut Value: 0.2
 - Window min/max (hours): -20, 0
 - Window Midpoint: 0
 - Smooth Range: 60
 - Buffer Size: 10
- Buttons:** Run, Load, Save
- Footer:** Off/On toggle, Safety Mode, Done, Plotting, Done

Used MATLAB to build views

Results of Digital Transformation at GSK

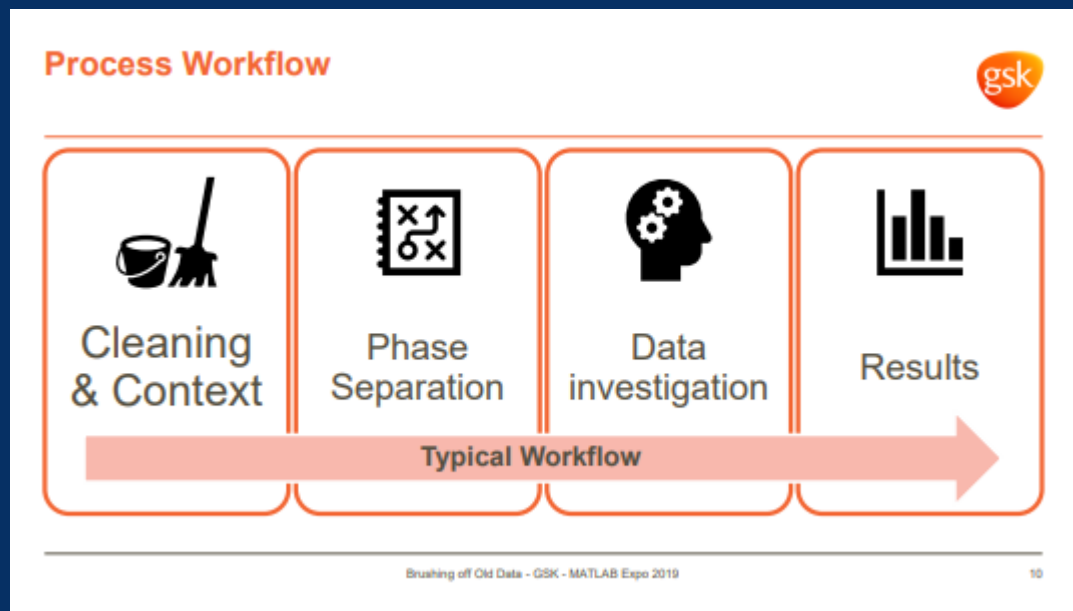

Systematic use of data

- Combine siloed data
- Sort and tag
- Views to select

Can now use data to answer questions

- What affects the process
- How is each phase performing
- What happens if we adjust parameters

Benefits

- Reduced time to market for new formulas
- Automated reports for process improvement
- Added capacity without building a new factory

What is new to make this easier?

OPC UA

Access plant data securely from OPC UA-compliant servers.

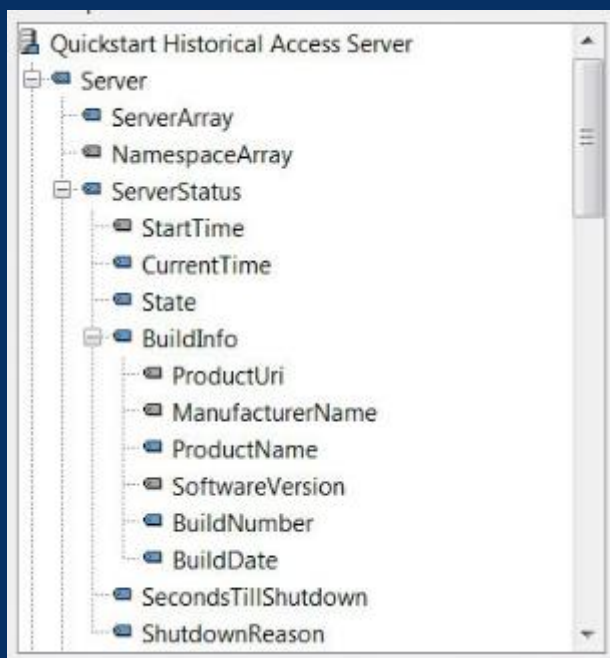

Live Editor Tasks

Apps that help you reduce development time and errors

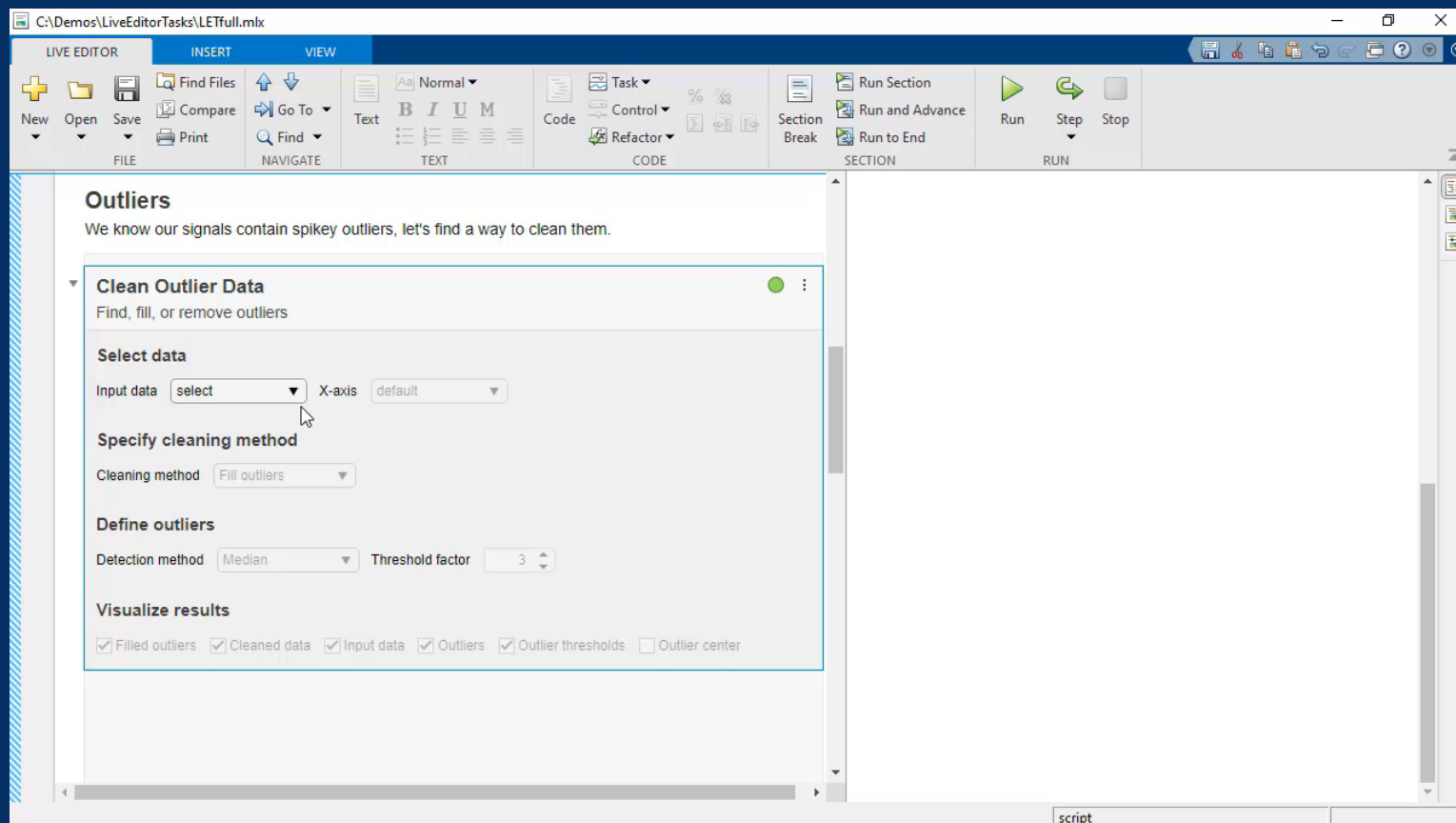

Predictive Maintenance Toolbox

Design condition indicators and estimate RUL of machinery

Systematic Use of Models

Model-Based Design: Systematic Use of Models in Development

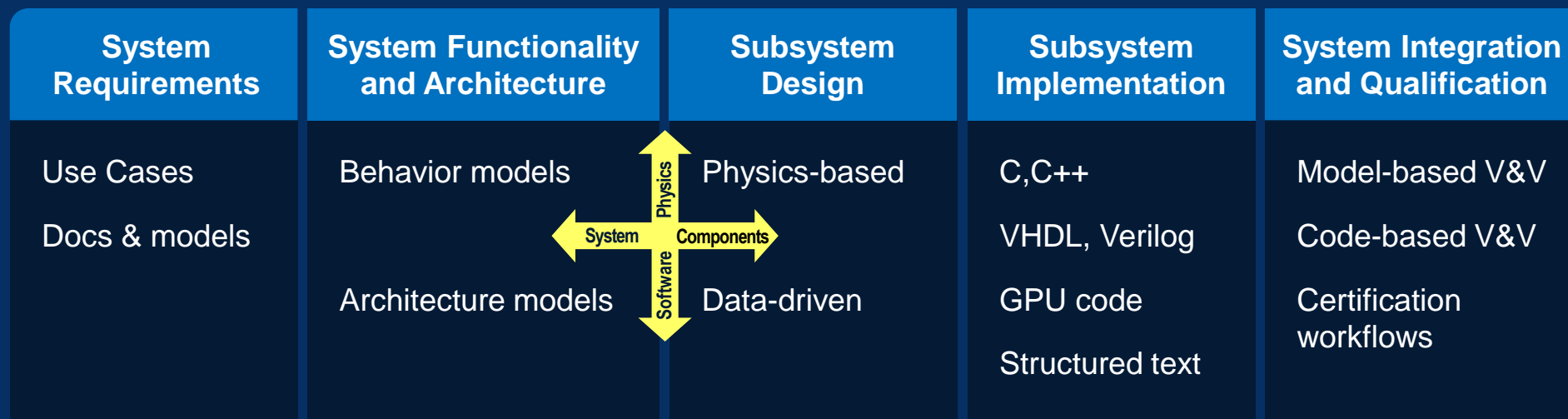

Digital Thread

Model-Based Design: Systematic Use of Models in Development

System Requirements	System Functionality and Architecture	Subsystem Design	Subsystem Implementation	System Integration and Qualification
Use Cases Docs & models	Behavior models Architecture models	Physics-based Data-driven	C,C++ VHDL, Verilog GPU code Structured text	Model-based V&V Code-based V&V Certification workflows
	AI 	Data labeling Training Quantizing	C,C++ GPU code	AI Integration in Simulink models

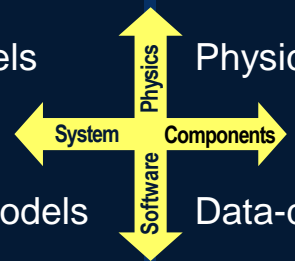

Example: Reinforcement Learning for Autonomous Vehicles

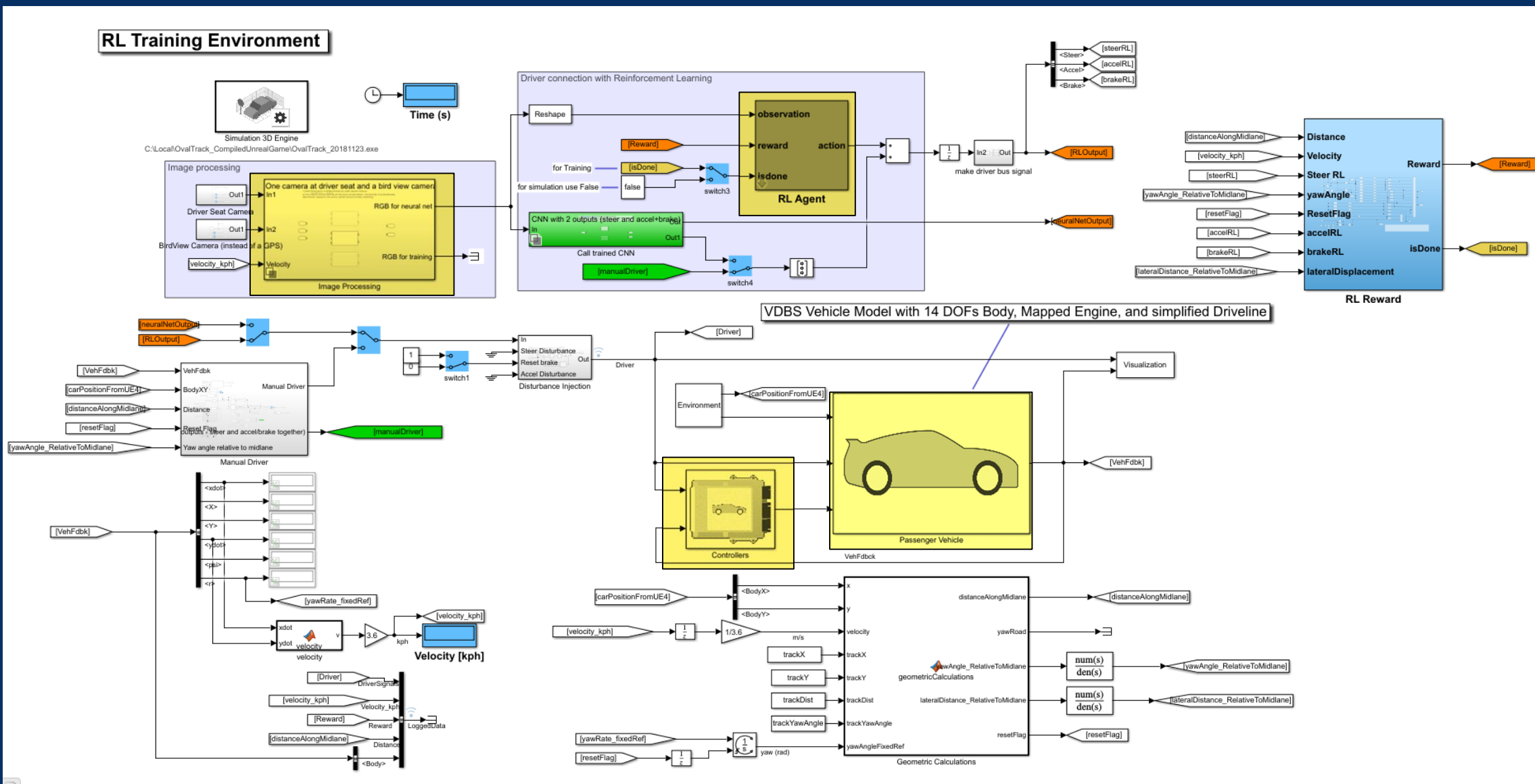

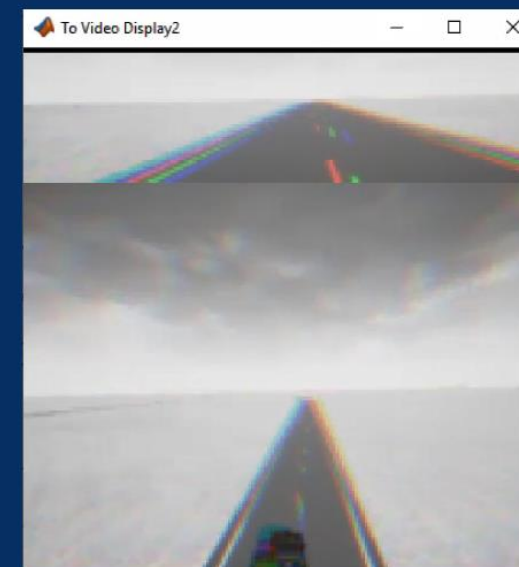
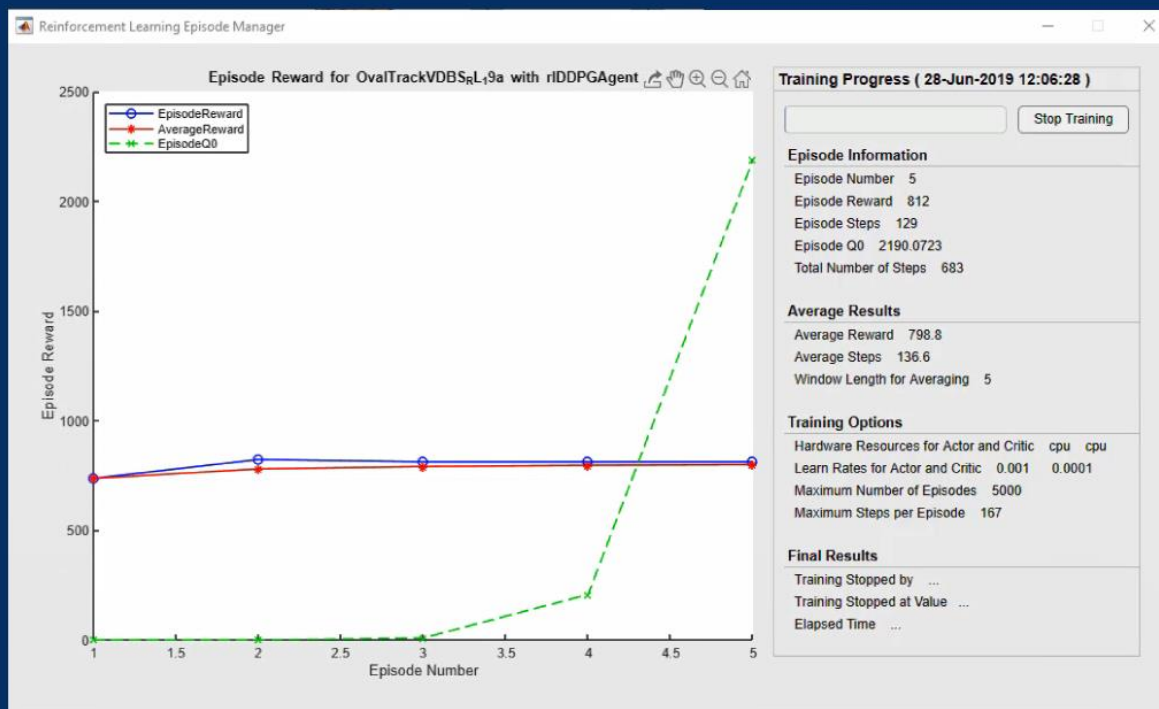

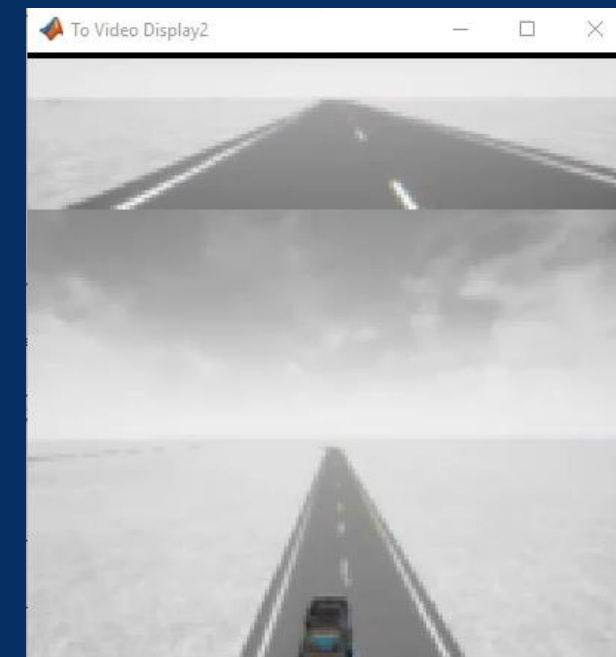
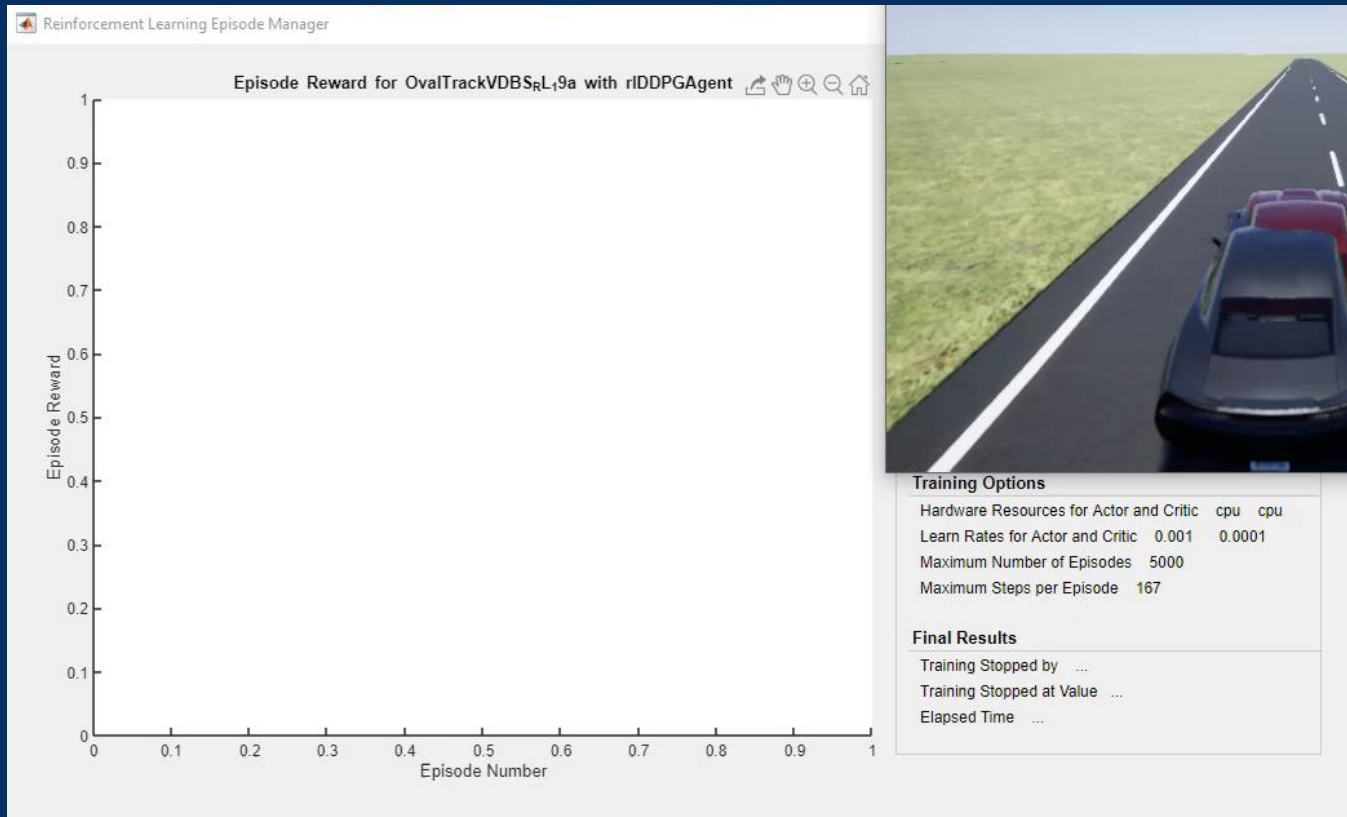

Extending Through the System's Lifecycle

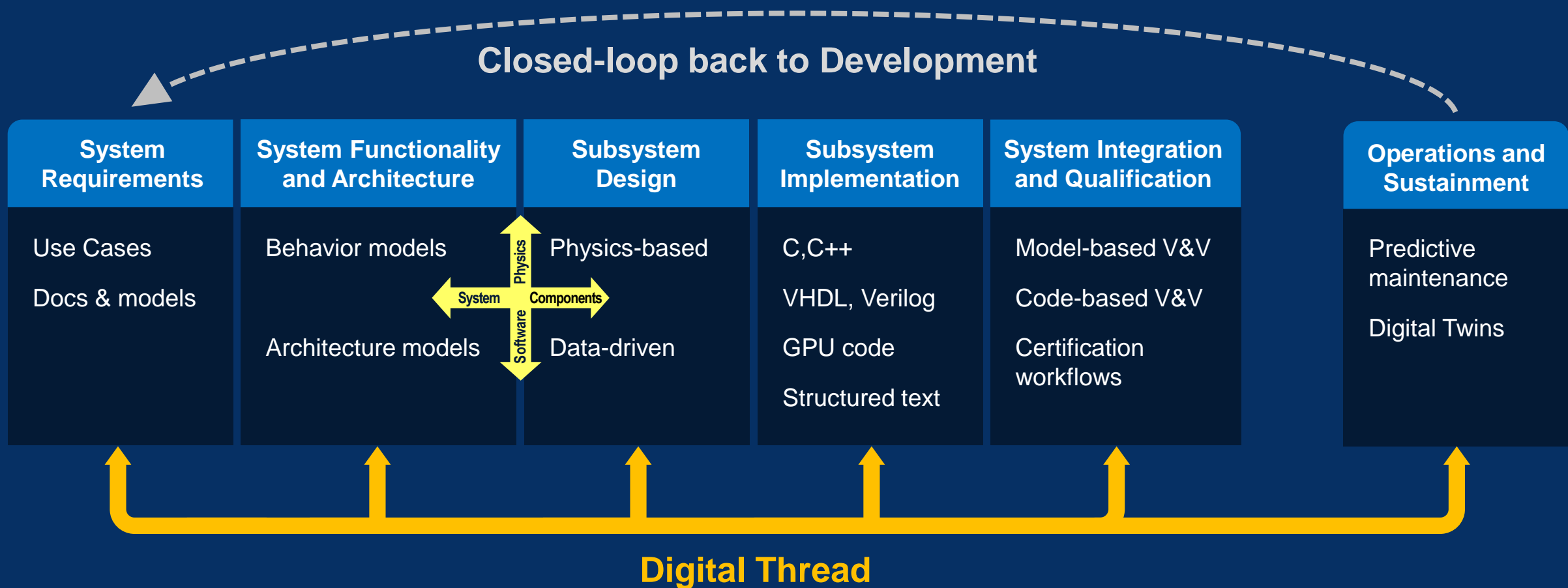

Case Studies: Use of Data and Models in Operation



Atlas Copco: Digital thread for compressor systems

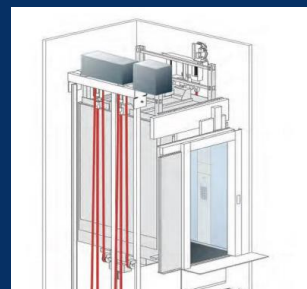

Schindler Elevator: Virtual commissioning



BuildingIQ: Predictive energy optimization



Tata Steel: Controller optimization

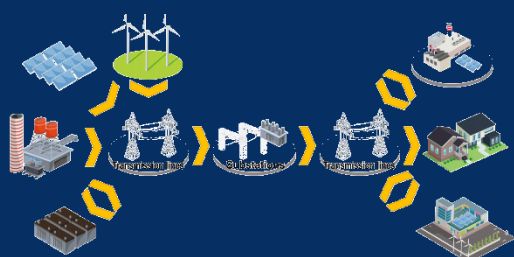

Fuji Electric: Real-time analysis of Smart Grid



Lockheed: Aircraft fleet management



Mining company: Fault detection and predictive maintenance

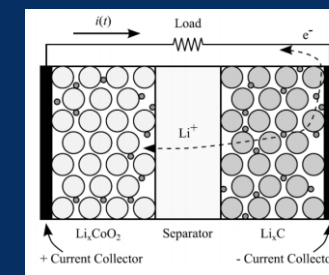

NIO: Battery management for electric vehicles

Atlas Copco: Challenges



Air Compressor System

- Shorter Time to Market
- Cross divisional development
- Improve reliability and efficiency
- Control total development, production and service costs
- High product variability

Atlas Copco

System Lifecycle Use with MATLAB & Simulink

As Designed
As Configured
As Produced
As Maintained

As Maintained: > 120.000 Machines Connected

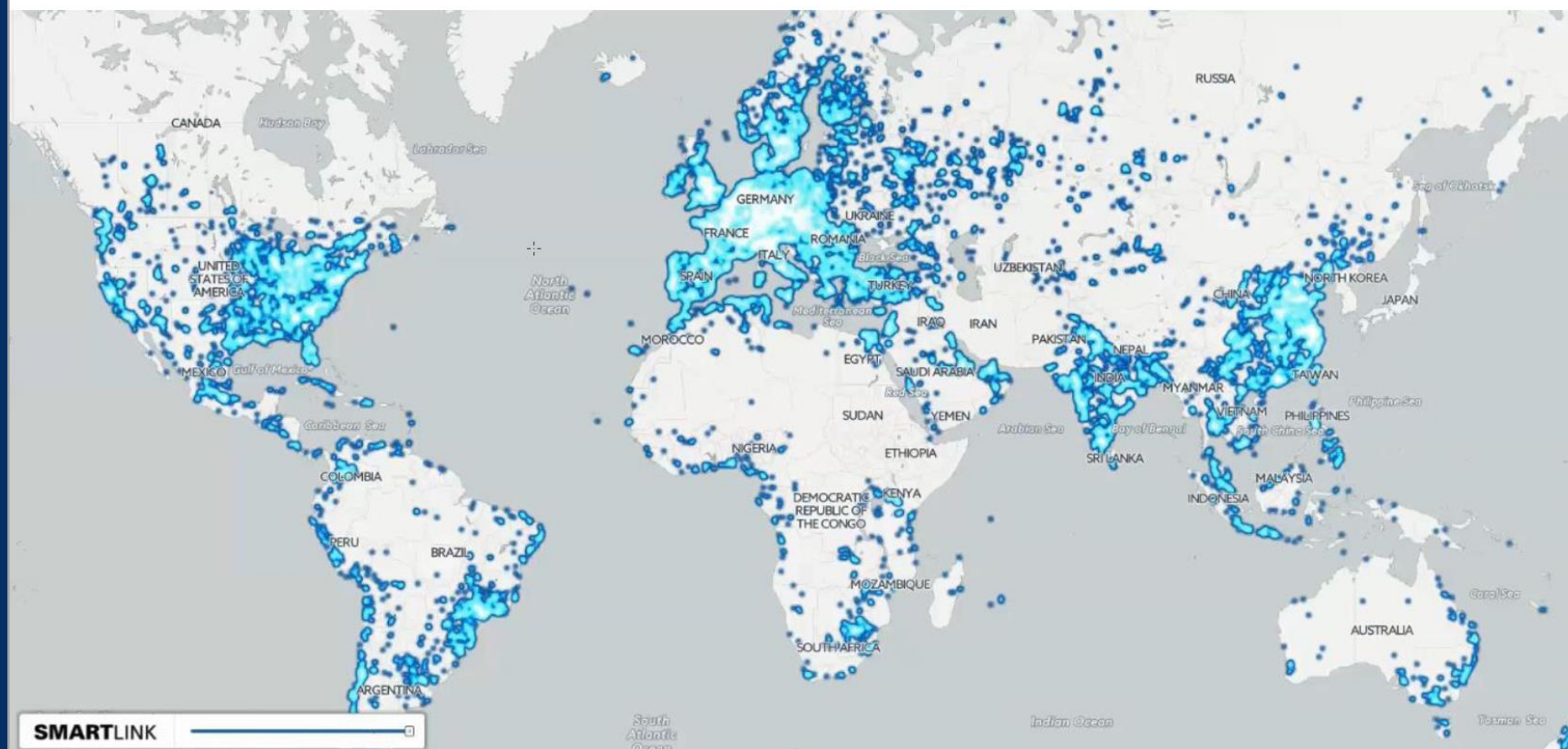

As Achieved: Standardized Model Based Engineering Platform

Process

- Company-wide workflow
- Used throughout product lifecycle
- Optimized maintenance and Data Analytics platform
- Continuously updated digital twins

People

- Collaboration platform for efficient communication
- Standardized accurate configuration tool used by global sales

Results

- 120k+ connected machines
- Quick implementation of upgrades
- Re-establishing Atlas Copco as undisputed global market leader

What is new to make this easier (more powerful/effective)?

Simulink Requirements

View: Requirements

Index	ID	Summary
scExampleSmallUAVModel		
1	#1	Aircraft Capabilities
1.1	#3	Airworthiness
1.1.1	#5	Range
1.1.2	#6	Rain Conditions
1.1.3	#7	Power
1.1.4	#8	Emergency Power
1.1.5	#9	Control Surface Fault-Tolerance
1.1.6	#10	Fuel
1.1.7	#19	No Payload Flights
1.1.8	#21	Flight Data Recorder
1.1.9	#22	Flight Identification



System Composer

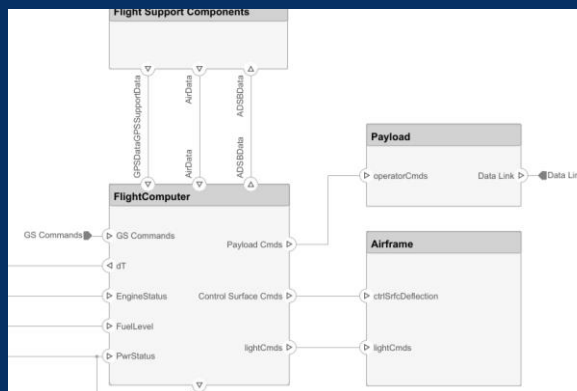

Simulink

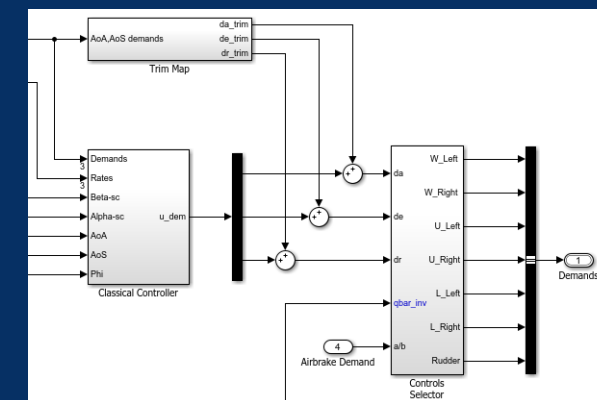

What is new to make this easier (more powerful/effective)?

Simulink Requirements

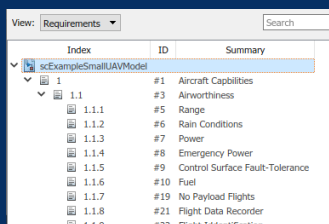

System Composer

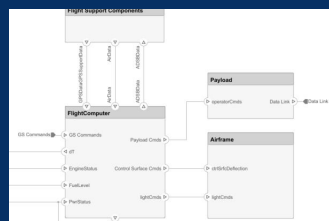

Simulink

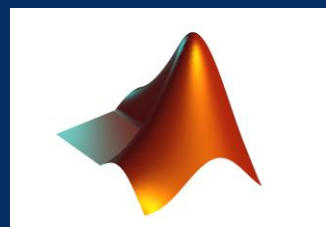
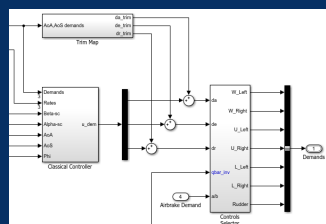

MATLAB

Digital Twins and Predictive Maintenance

Big Data/Dashboards



Cloud



Edge



Embedded





A **Leader** in the Gartner Magic Quadrant for 2020 Data Science and Machine Learning Platforms

Figure 1. Magic Quadrant for Data Science and Machine Learning Platforms

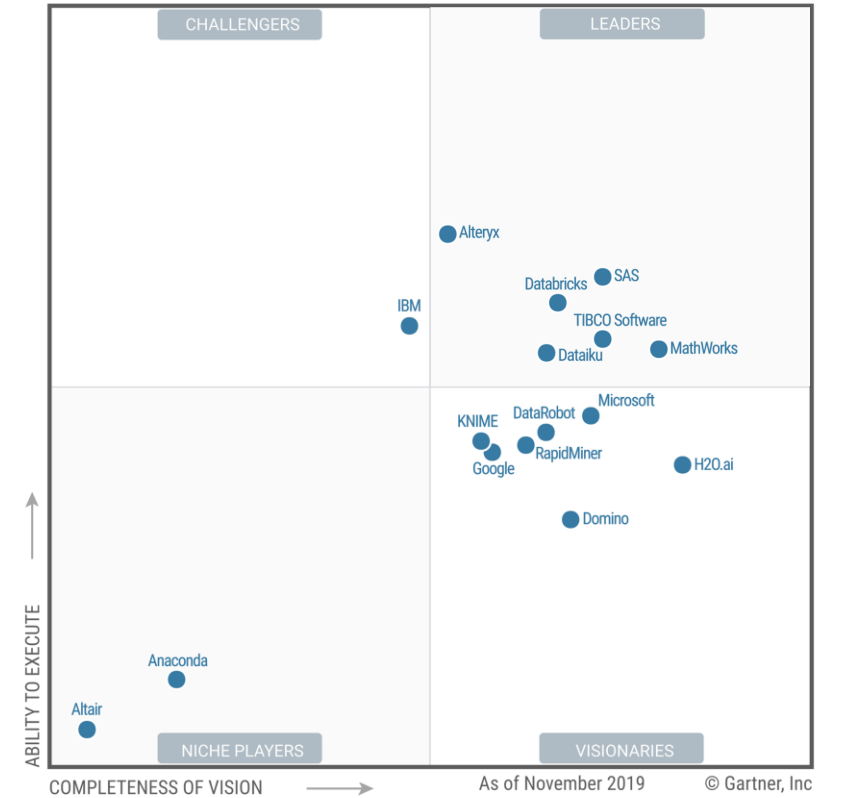

Source: Gartner (February 2020)

*Gartner Magic Quadrant for Data Science and Machine Learning Platforms, Peter Krensky, Erick Brethenoux, Jim Hare, Carlie Idoine, Alexander Linden, Svetlana Sicular, 11 February 2020 .

This graphic was published by Gartner, Inc. as part of a larger research document and should be evaluated in the context of the entire document. The Gartner document is available upon request from MathWorks. Gartner does not endorse any vendor, product or service depicted in its research publications, and does not advise technology users to select only those vendors with the highest ratings or other designation. Gartner research publications consist of the opinions of Gartner's research organization and should not be construed as statements of fact. Gartner disclaims all warranties, express or implied, with respect to this research, including any warranties of merchantability or fitness for a particular purpose.



A **Leader** in the Gartner Magic Quadrant for 2020 Data Science and Machine Learning Platforms

We believe this recognition demonstrates our ability to:

- Empower teams, even those with limited AI experience
- Support entire AI workflows
- Deploy to embedded, edge, enterprise, and cloud
- Tackle integration challenges
- Manage risk in designing AI-driven systems

Figure 1. Magic Quadrant for Data Science and Machine Learning Platforms

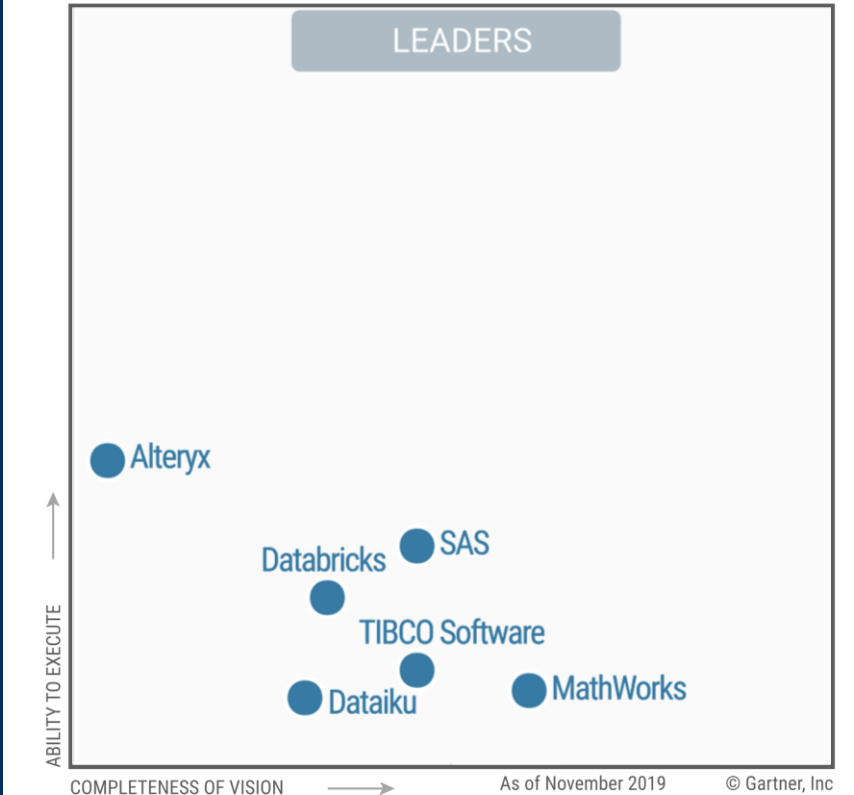

Source: Gartner (February 2020)

*Gartner Magic Quadrant for Data Science and Machine Learning Platforms, Peter Krensky, Erick Brethenoux, Jim Hare, Carlie Idoine, Alexander Linden, Svetlana Sicular, 11 February 2020 .

This graphic was published by Gartner, Inc. as part of a larger research document and should be evaluated in the context of the entire document. The Gartner document is available upon request from MathWorks. Gartner does not endorse any vendor, product or service depicted in its research publications, and does not advise technology users to select only those vendors with the highest ratings or other designation. Gartner research publications consist of the opinions of Gartner's research organization and should not be construed as statements of fact. Gartner disclaims all warranties, express or implied, with respect to this research, including any warranties of merchantability or fitness for a particular purpose.

Why MathWorks for Pragmatic Digital Transformation?

Systematic use of data and models

MATLAB®
& SIMULINK®

to create and deliver superior value
to customers

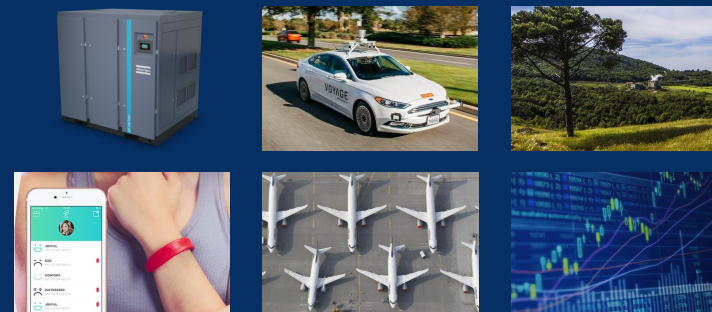

throughout the entire lifecycle

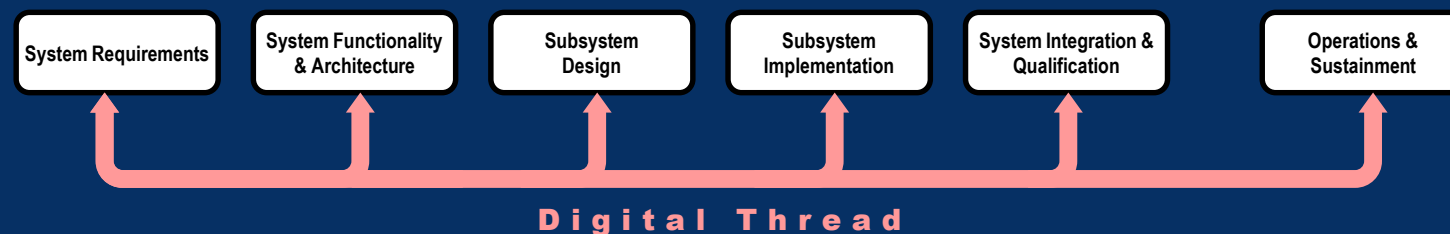

Keep in mind today:

How can **you** systematically use models and data as part of **your** pragmatic digital transformation?

Enjoy the Conference!